



# Mast Pak

*Surgical Corporation*

Manufacturer & Exporters of surgical instruments



WHERE ORTHOPAEDIC CARE  
IS AN ARTFORM

## Orthopedic Surgery

**Instruments**

Website: [www.mastpaksurgicalcorp.com](http://www.mastpaksurgicalcorp.com)

Email: [info@mastpaksurgicalcorp.com](mailto:info@mastpaksurgicalcorp.com)

Phone: +92-324-8609456

Address: Pacca Garha, Kashmir Road  
Sialkot 51310, Pakistan

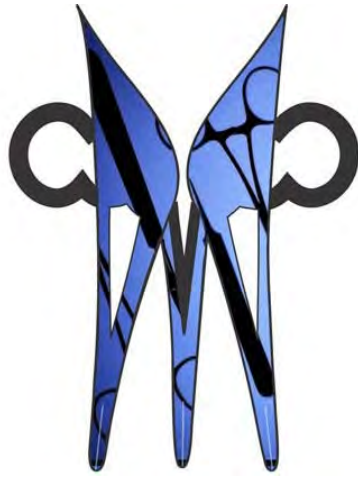

# ***Mast Pak Surgical Corporation***

*Customer Satisfaction is Our priority*

**Mast Pak Surgical Corporation** is engaged in Designing, Manufacturing and Distribution of 100% pure quality Stainless Steel surgical instruments for all department of surgery in the Sialkot 51310, Pakistan

**Mast Pak Surgical Corporation** is a rare union of highly skilled surgical craftsmen, guaranteed raw material and modern technology that results in high quality surgical instruments

We take great pride in the extensive range of over 15,000 quality instruments that we offer in a multitude of disciplines.

Our dedicated R&D department has acclaimed many golden feathers in their hat by modifying, designing and manufacturing complex instruments according to surgeon's requirements.

Even more importantly, we have a very significant policy of effective 'service after sales' to the satisfaction of our entire clients.

# INDEX

	Page No.
<b>ELEVATORS</b>	
Adson Periosteal Elevator	1
Pennybacker Periosteal Elevator	1
Bone Raspatory with Tufnol Handle	1
Farabeuf Rugine Elevator	1
Trethowan Bone Elevator	2
Lanes Bone Elevator	2
Fagge Bone Elevator	2
Bristow Periosteal Elevator	2
Femoral Dislocation Lever	2
Muller Femoral Retractor	2
Mini Bone Lever	3
Hohmann Style Mini-Bone Lever	3
Phalangeal Lever	3
Buck-Gramcko Lever	3
Mini-Cobra Bone Lever	3
McGlamry Metatarsal Elevator	3
Hohmann Bone Elevators	4 & 5
Modified Cobra Aufrang Elevator	5
Shallow Bone Elevator	5
Concave Moor Elevator	5
Murphy Bone Skid Elevator	6
Infero-Posterior Acetabular Retractors	6
PCL Retractor	6
Wide Prong PCL Retractor	6

<b>BONE HOOKS</b>	
Bone Hook Sharp	7
Blunt Hook	7
Wroblenski Dislocating Hook	7
McMinn Dislocating Hook	7

<b>BONE SPREADERS</b>	
Scaphoid Spreaders	8
Baby Inge Bone Spreader	8
Scaglietti Lamina Spreader	8

<b>BONE CUTTERS</b>	
Bohler Bone Cutters	9
McIndoe Bone Cutters	9
Ruskin-Liston Bone Cutters	9
Stille-Liston Bone Cutters	9
Liston-Key-Horsley Bone Cutters	9

<b>BONE NIBBLERS</b>	
Kleinert-Kutz Bone Nibbler	10
Lempert Bone Nibbler	10
Luer Bone Nibbler	10
Adsons Bone Nibbler	10
Bohler Bone Nibbler	11
Marquardt Bone Nibbler	11
Beyer Bone Nibbler	11
Jansen Bone Nibbler	11
Smith-Peterson Bone Nibbler	12
Leksell Bone Nibbler	12
Stille-Luer Bone Nibbler	12
'Mr Blobby' Stille-Luer Bone Nibbler	12

	Page No.
<b>BONE HOLDING FORCEPS</b>	
Langenbeck Bone Holding Forceps	13
Frosch Bone Holding Forceps	13
St. Thomas Bone Holding Forceps	13
Fergusson Bone Holding Forceps	13
Langenbeck Bone Holding Forceps	13
Semb Bone Holding Forceps	14
Hey Groves Bone Holding Forceps	14
Verbrugge Bone Holding Forceps	14

<b>PELVIC REDUCTION INSTRUMENTS</b>	
Pelvic Reduction Forceps	15 & 16

<b>RETRACTORS</b>	
Meyerding Retractor	17
Langenbeck Retractor	17
Volkman Catspaw	17
Charnley Initial Incision Retractor Set	18
West's S/R Retractor	19
Weitlaner S/R Retractor	19
Travers S/R Retractor	19
Norfolk and Norwich S/R Retractor	19
Gelpi Laminectomy Retractor	19
Charnley Vertical Retractor	20
Cones Self Retaining Retractor	20
Harvey Jackson Self Retaining Retractor	20
Charnley Horizontal Hip Retractor	21
Hardinge Horizontal Retractor	21
Charnley Pin Retractor	21
Viper Scoliosis Retractors	22

<b>MALLETS</b>	
Toffee Mallet	23
Ultra Fine Mallet	23
Heath Mallet	23
Mallet with Tufnol Handle	23
London Splint Mallet	24
Ombredanne Mallet	24
Mallet with Tufnol Handle - lead filled head	24
Tufnol Mallet	24

<b>OSTEOTOMES</b>	
Mini-Lambotte Osteotome	25
Lambotte Osteotome	25
Ultra Fine Osteotome	25
Mini-Stille Osteotome	26
Stille (Swedish) Osteotome	26
Hibbs Osteotome with thin blade	26
Smith Petersen Osteotome	26
Mini-Lexer Osteotome	27
Lexer Osteotome	27
Dahmen Osteotome	27
Box Chisel	28
Pelvic Osteotome	28
Chisel with 4 Interchangeable Blades	28
Capener Lamina Gouge	28

# INDEX

	Page No.
<b>BONE CURETTES</b>	
Volkman Curette	29
Muller Curette with Tufnol Handle	29
Charnley Bone Curette	29
Charnley Ring Curette	29

## HIP RIVISION INSTRUMENTS

Cup Extraction Chisel	30
Bayonet Gouge	30
Swan Necked Gouge	30
Cement Gouge	30
Cement Chisel Angled 15°	30
Cement Osteotome	31
Cement Splitting Osteotome	31
Straight Cement Gouge	31
Bayonet Cement Rasp	31
Bayonet Cement Chisel	32
Bayonet Cement Splitting Osteotome	32
Bayonet Cement Gouge	32
Malleable Cement Probe	33
Cement Plug Extractor	33
Retrograde Cement Chisel	33
Slotted Mallet	33
Cement Extraction Hook	33
Cement Twist Drill	34
Fine Cement Duckbill Grasping Forceps	34
Heavy Cement Grasping Forceps	34
Femoral Head Extractor	35
Moore Femoral Head Extractor	35
Joint Capsule Clamp	35
Joint Capsule Scissors	35

## HIP JOINT INSTRUMENTS

Femoral Head Impactor	36
McGoey Bone Punch	36
Hardinge Cement Restrictor	36
Femoral Pusher	36

## PLIERS & WIRE CUTTERS

Universal Fine Pliers & Cutters	37
Slim & Square Ended Wire Pliers	37
Pliers for Screw Removal	37
Muller Claus Wire Pullers	37
Muller Claus Wire Cutters	38
End Wire Cutters	38
Bolt Cutters with dismantable arms	38
Combined Wire Cutters & Pliers	39
Wire Cutters with T/C Jaws	39
'Power Cut' Wire Cutters	39

## LOCKING PLIERS

Needle Nosed Locking Pliers	40
Orthopaedic Locking Pliers	40

## PIN INTRODUCERS

Kirschner Wire Introducing T-Handle	41
Steinmann Pin Introducer T-Handle	41

## MISC

Bone Mill	42
Wire Passing Guide	42
Bone Awl	42

## SCREWDRIVERS

Slotted Head Screwdriver	43
Long Slotted Head Screwdriver	43
Phillips Head Screwdriver	43
Cross Slotted Head Screwdriver	43
Hexagonal Head Screwdriver	44

## DISSECTORS

Howarth Elevator	45
MacDonald Elevator/Dissector	45
Watson Cheyne Dissector	45
Freers Elevator/Dissector	45
Swedish Dissector	45

## MEASURING INSTRUMENTS

Stainless Steel Measuring Ruler	46
Measuring Caliper	46
Vernier Caliper	46
Depth Gauge	46

## ARTHROSCOPY PUNCHES

Slimline Basket Punch	47
Regular Basket Punch	47
Duckbill Basket Punch	48
Duckling Basket Punch	48
Scissor Punch	49
Biopsy Rongeur	49
Hook Scissors	50
Oval Punch	50
Back Biter Punches	51
Scoop Basket Punch	51
Grasping Forceps	52

## ARTHROSCOPES

Stryker Compatible	53
Dyonics Compatible	54
Regular Fitting	55

## FIBRE OPTIC LIGHT LEAD

Fibre Optic Light Lead	56
Adaptors for Light Lead	56

## DRILLS & K-WIRES

Twist Drills	57
Kirschner Wires	58

## OPERATING CHAIRS

The Severn Surgeons Operating Stool	59
The Avon Surgeons Operating Stool	59
Coburg Micro Surgery Stool	60



# ELEVATORS

## Adson Periosteal Elevator

16cm/6¼" length  
Curved blunt

	Width
OR3055-16	5mm
OR3007-16	7mm



## Pennybacker Periosteal Elevator

16cm/6¼" length  
Curved sharp

	Width
OR3064-16	4mm
OR3066-16	6mm
OR3068-16	8mm



## Bone Raspatory with Tufnol Handle

19cm/7½" length

Straight	Width
OR7016-19	6mm



Curved	Width
OR7023-19	3mm
OR7026-19	6mm

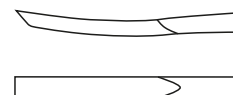

## Farabeuf Rugine Elevator

15cm/6" length

Straight	Width
OR3001-15	12mm

Curved*	Width
OR3002-15	12mm



\*illustrated

## Farabeuf Rugine Elevator with Hollow Handle

16cm/6¼" length

Straight	Width
OR3011-16	12mm

Curved*	Width
OR3012-16	12mm



\*illustrated

# ELEVATORS



## Trethowan Bone Elevator

- 22.5cm/8½" length

OR3030-22



## Lanes Bone Elevator

- 26cm/10" length

OR3031-26



## Fagge Bone Elevator

- 27.5cm/10¾" length

OR3032-27



## Bristow Periosteal Elevator

- 23cm/9" length
- Curved sharp
- 10mm width

OR3003-23



## Femoral Dislocation Lever

- 31cm/12½" length
- 26mm width

OR3026-31



## Muller Femoral Retractor

- 35cm/13½" length
- 28mm width

OR3028-35



For retraction of the femoral neck.

# MINI ELEVATORS

## Mini Bone Lever

14cm/5½"  
2.8mm width

OR5830-14



## Hohmann Style Mini-Bone Lever

16cm/6¼"  
6mm width

OR5831-16



## Phalangeal Lever

15cm/6"  
5mm width

OR5832-16



## Buck-Gramcko Lever

15cm/6"  
7.5mm width

OR5833-15



## Mini-Cobra Bone Lever

16cm/6¼"  
15mm width

OR5834-16



## McGlamry Metatarsal Elevator

17cm/6½"  
Sharp

	Width
OR5835-10	9mm
OR5835-12	11mm
OR5835-14	13mm
OR5835-16	15mm
OR5835-19	19mm



# ELEVATORS



**MAST PAK SURGICAL CORP.**

## Hohmann Bone Elevator

- 22cm/8½" length
- 8mm width

OR3008-22



## Hohmann Bone Elevator

- 24cm/9½" length
- 18mm width

OR3018-24



## Hohmann Bone Elevator

- 24.5cm/9½" length
- 43mm width

OR3043-24



## Hohmann Large Bone Elevator

- 24cm/9½" length
- 70mm width

OR3070-24



## Hohmann Bone Elevator

- 28cm/11" length
- 33mm width

OR3033-28



## Hohmann Bone Elevator

- 26cm/10" length
- 24mm width

OR3024-26





# ELEVATORS



## Long Curved Hohmann Inferior Hip Elevator

- 40cm/16" length
- 22mm width

OR3022-40

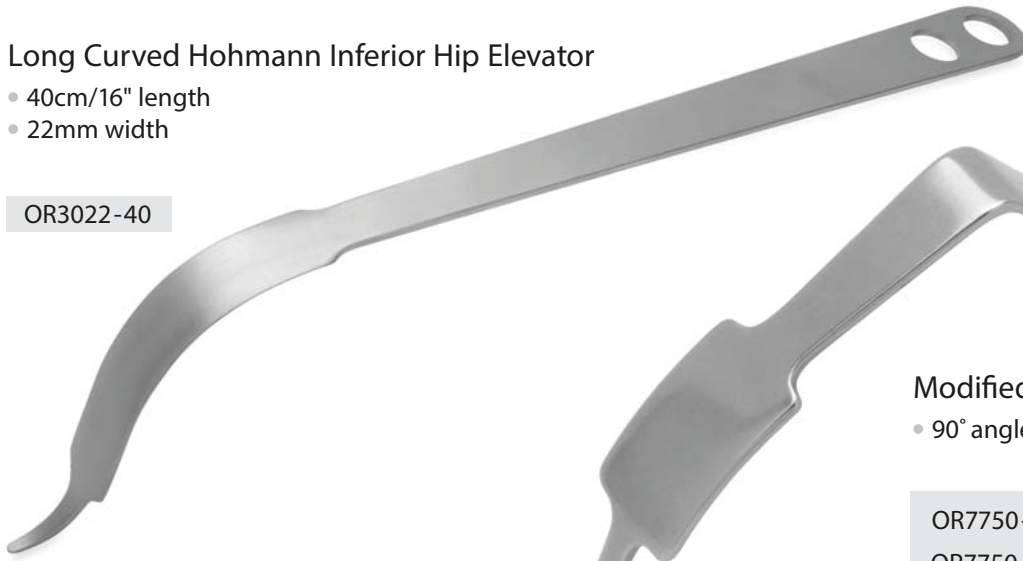

## Modified Hohmann Elevator

- 90° angled

Width

OR7750-10	10mm
OR7750-18	18mm
OR7750-25	25mm
OR7750-43	43mm
OR7750-70	70mm



## Modified Cobra Aufrang Elevator

- 33cm/13" long blade
- 30mm x 100mm

OR7742-10



## Shallow Bone Elevator

- 25cm/9¾" length

OR7755-25



## Concave Moor Elevator

- 33cm/13" long blade

OR7742-20



# ELEVATORS



**MAST PAK SURGICAL CORP.**

## Murphy Bone Skid Elevator

- 28cm/11" length
- For dislocation of the femoral head
- Double ended

OR0589-23



## Infero-Posterior Acetabular Capsule Retractor

- 35cm/14" length

Right

OR7772-10

Left

OR7772-20

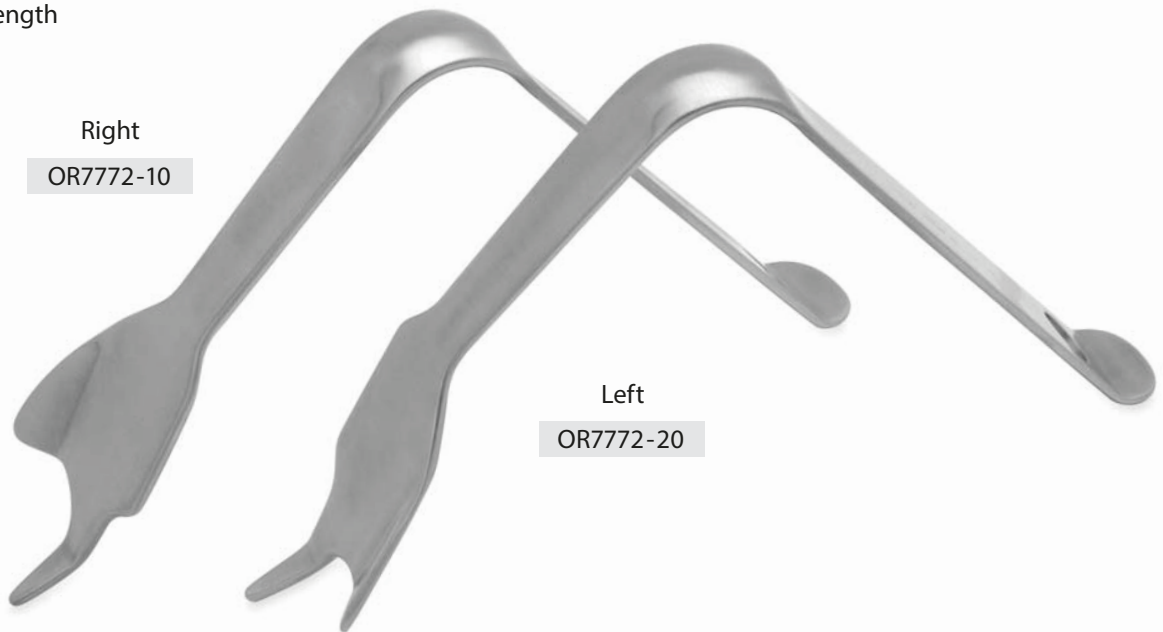

## PCL Retractor

- 25cm/10" length
- To straddle the cruciate ligament
- 4mm wide prongs
- 21mm wide tips

OR7761-10



## Wide Prong PCL Retractor

- 25cm/10" length
- To straddle the cruciate ligamen
- 5mm wide prongs
- 23mm wide tips

OR7762-10



# BONE HOOKS



**MAST PAK SURGICAL CORP.**

## Bone Hook Sharp

- 24.5cm/9¾" length
- Sharp

OR9050-24



## Blunt Hook

- 20cm/8" length

OR9051-20



## Wroblenski Dislocating Hook

- 25cm/10" length
- For hooking around the neck of the Femur

OR9055-25



## McMinn Dislocating Hook

- 25cm/10" length
- Blunt hook with Tufnol handle

OR9057-25



# BONE SPREADERS

## Scaphoid Spreader - Fine Pattern

14cm/5½" length  
1 x 2 prongs

6mm

OR5131-14



## Scaphoid Spreader - Standard Pattern

14cm/5½" length

6mm

OR5134-14



## Baby Inge Bone Spreader

18cm/7" length

7mm  
Toothed



OR5134-18

7mm  
Smooth



OR5134-18S

7mm  
Cross Serrated



OR5134-18X



## Scaglietti Lamina Spreader

28cm/11" length  
With speed lock



OR2009-28



# BONE CUTTERS

## Bohler Bone Cutters

15cm/6" length  
Double action

Straight  
OR5160-50

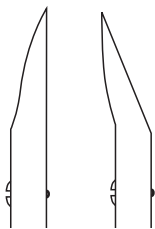

Angled  
OR5161-50



## McIndoe Bone Cutters

- 18cm/7" length
- Double action
- Angled jaws



OR1028-18



## Ruskin-Liston Bone Cutters

19cm/7½" length  
Double action



Straight  
OR5170-19



Angled  
OR5171-19



## Stille-Liston Bone Cutters

- 27cm/10¾" length
- Double action



Straight  
OR1024-27



Angled  
OR1025-27

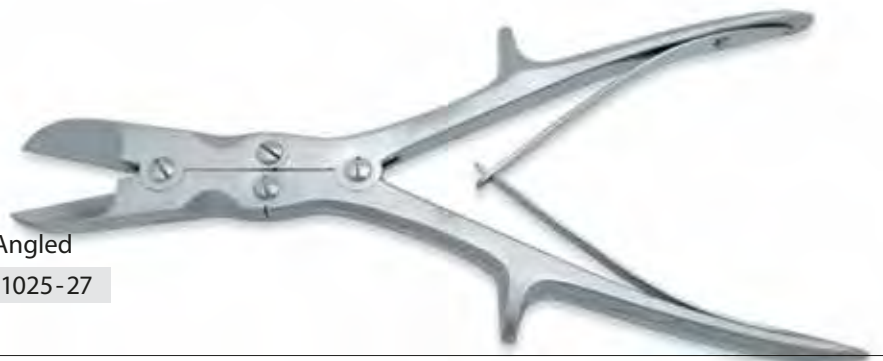

## Liston-Key-Horsley Bone Cutters

- 27cm/10¾" length
- Double action
- Angled



OR1023-27



# BONE NIBBLERS



## Kleinert-Kutz Bone Nibbler

14cm/4½" length  
Curved

2mm Bite

OR5118-50



## Lempert Bone Nibbler

19cm/7½" length  
Single action

3mm Bite

OR1001-19



## Luer Bone Nibbler

18cm/7" length  
Single action

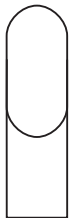

Straight  
8mm Bite

OR1004-18



Curved  
8mm Bite

OR1005-18



## Adsons Bone Nibbler

20cm/8" length  
Single action



7mm Bite

OR1040-20



# BONE NIBBLERS



**MAST PAK SURGICAL CORP.**

## Bohler Bone Nibbler

Curved double action  
15cm/6"

3mm Bite

OR5120-50

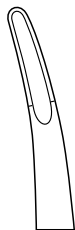

## Marquardt Bone Nibbler

- 20cm/8" length
- Curved double action

3mm Bite

OR1002-20

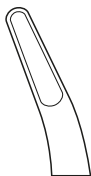

## Beyer Bone Nibbler

Curved double action  
18cm/7"

4mm Bite

OR1002-18

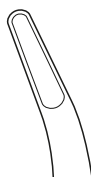

## Jansen Bone Nibbler

Curved double action  
18cm/7"

5mm Bite

OR1003-18

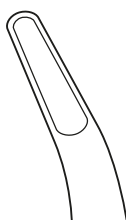

# BONE NIBBLERS

## Smith-Peterson Bone Nibbler

- 24cm/9½" length
- Double action

Straight	Light Curve	Bite Size
OR1010-24	OR1014-24	3mm
OR1011-24	OR1015-24	4mm
OR1012-24	OR1016-24	5mm
OR1013-24	OR1017-24	6mm

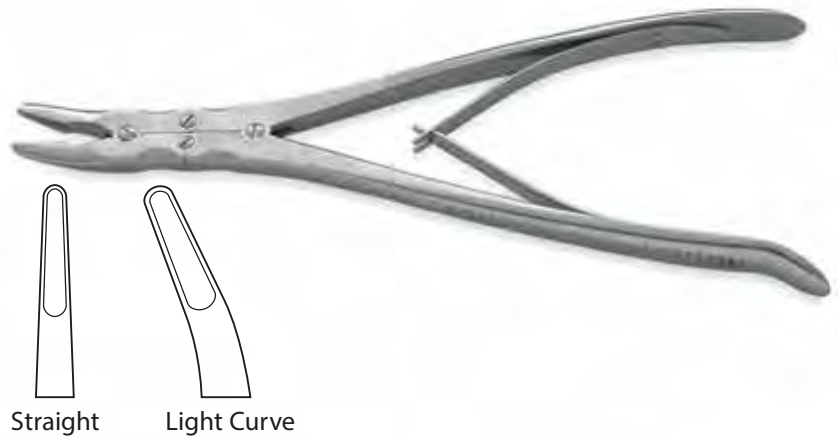

## Leksell Bone Nibbler

- 24cm/9½" length
- Double action angled

Angled Jaw	Bite Size
OR1018-24	3mm
OR1019-24	5mm
OR1020-24	8mm

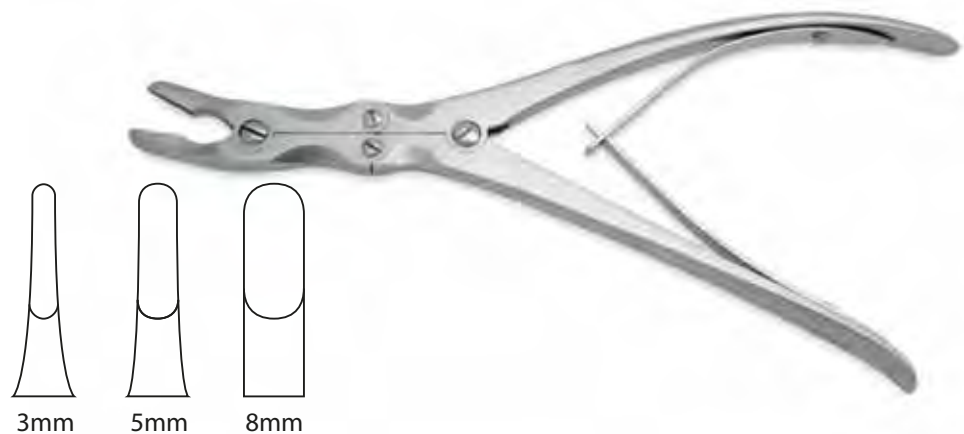

## Stille-Luer Bone Nibbler

- 22cm/8¾" length
- Double action

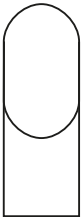
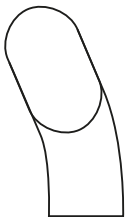
	
Straight 10mm Bite	Curved 10mm Bite
OR1006-22	OR1007-22



## 'Mr Blobby' Stille-Luer Bone Nibbler

- 26cm/10¼" length
- Double action

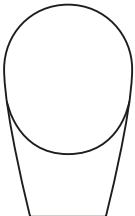
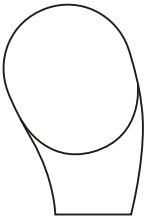
	
Straight 17mm Bite	Curved 17mm Bite
OR1008-26	OR1009-26





# BONE HOLDING FORCEPS



MAST PAK SURGICAL CORP.

## Langenbeck Bone Holding Forceps

20cm/8" length

OR5120-05

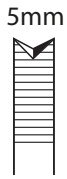

## Frosch Bone Holding Forceps

- 18cm/7" length
- Toothed/serrated jaws

OR6141-18



## St. Thomas Bone Holding Forceps

- 18cm/7" length
- Screw joint

OR6170-18



## Fergusson Bone Holding Forceps

- 20cm/8" length
- Screw joint

OR6140-20



## Langenbeck Bone Holding Forceps

- 21cm/8¼" length

OR6144-21



# BONE HOLDING FORCEPS



**MAST PAK SURGICAL CORP.**

## Semb Bone Holding Forceps

- 19cm/7½" length
- Angled to side

OR6147-18



## Hey Groves Bone Holding Forceps

- Screw joints
- Serrated jaws



### Length

OR6145-20	20cm/8"	Small
OR6145-25	25.5cm/10"	Medium
OR6145-30	30.5cm/12"	Large

## Verbrugge Bone Holding Forceps



### Length

OR6150-25	25cm/10"	Small
OR6150-26	26cm/10½"	Medium
OR6150-27	27cm/11"	Large

# PELVIC REDUCTION INSTRUMENTS

## Pelvic Reduction Forceps

- 19cm/7½" length
- Angled, small
- Pointed ball tips
- Speed lock

OR6151-19



## Pelvic Reduction Forceps

- 23cm/9" length
- Angled, large
- Pointed ball tips
- Speed lock

OR6152-23



## Pelvic Reduction Forceps

- 25cm/10" length
- Straight, large
- Pointed ball tips
- Speed lock

OR6153-25



# PELVIC REDUCTION INSTRUMENTS

## Pelvic Reduction Forceps

- 40cm/16" length
- Pointed ball tips
- Speed lock

OR6154-40



## Pelvic Reduction Forceps

- 40cm/16" length
- 3 pointed ball tips
- Speed lock

OR6155-40



# RETRACTORS

## Meyerding Retractor

- 22cm/9" length



### Blade size

OR5050-22	50mm x 16mm
OR5075-22	70mm x 25mm
OR5090-22	90mm x 50mm

## Langenbeck Retractor

- 21.5cm/8½" length



### Blade size

OR5122-21	22mm x 6mm	Small
OR5145-21	45mm x 13mm	Medium
OR5165-21	65mm x 25mm	Large
OR5190-21	90mm x 20mm	Extra large

## Volkman Cataspaw Retractor

- 21.5cm/8½" length
- Semi sharp teeth

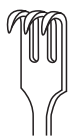

15 x 15mm  
3 Prong

OR5015-21



15 x 20mm  
4 Prong

OR5020-21

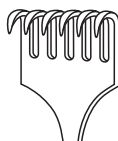

15 x 30mm  
6 Prong

OR5030-21

# HIP RETRACTORS

## Charnley Initial Incision Retractor Set

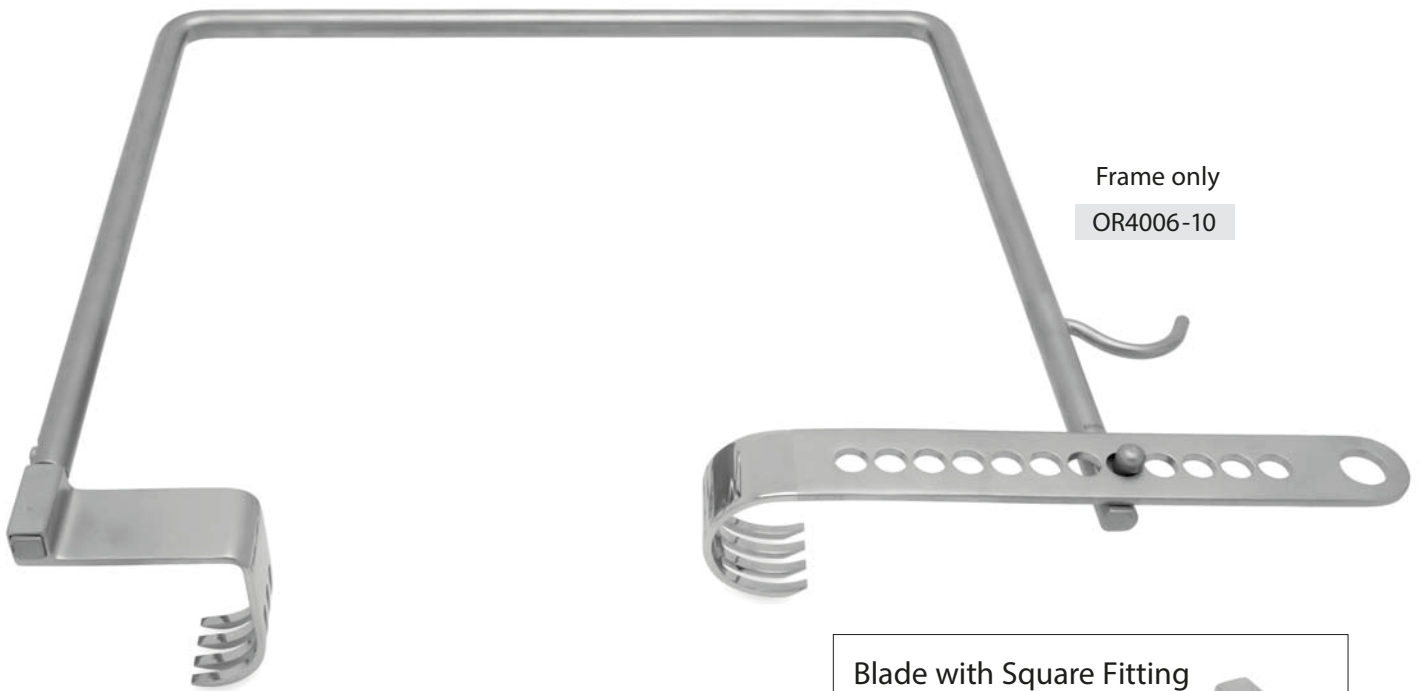

Frame only

OR4006-10

### OR4006-00 Complete Set - Basic

Consisting of:

- 1x Frame
- 1x Weight & chain
- 1x Square fitting blade - 50mm depth
- 1x Round fitting blade - 40mm depth

### OR4006-05 Complete Set - Extended

Consisting of:

- 1x Frame
- 1x Weight & chain
- 3x Square fitting blades:
  - 50mm depth
  - 75mm depth
  - 100mm depth
- 3x Round fitting blades:
  - 40mm depth
  - 75mm depth
  - 100mm depth

### Blade with Square Fitting



OR4006-50 Standard depth 50mm

OR4006-75 Extra depth 75mm

OR4006-10 Extra, extra depth 100mm

### Blade with Round Fitting

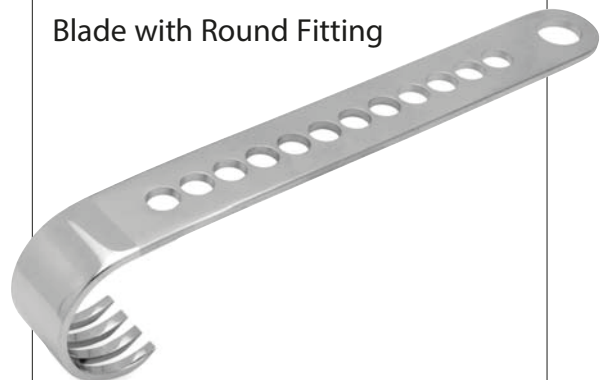

OR4007-40 Standard depth 40mm

OR4007-75 Extra depth 75mm

OR4007-10 Extra, extra depth 100mm

To spread the incision in the fascia lata. It is combined with a weight and chain, which tilts the retractor to an angle of 45° to improve exposure of the anterior aspect of the joint.



Weight & chain

OR4006-07

# RETRACTORS



## West's S/R Retractor

- 14cm/5½" length
- 3x4 Sharp prongs

OR4003-14



## Weitlaner S/R Retractor

- 14cm/5½" length
- 3x4 Blunt prongs

OR4002-14



## Travers S/R Retractor

- 20cm/8" length
- 4x5 Blunt prongs

OR4004-20



## Norfolk and Norwich S/R Retractor

- 20cm/8" length
- 4x5 Blunt prongs

OR4000-20



## Gelpi Laminectomy Retractor

- Sharp prongs

	Length	Prong depth
OR4030-16	18.5cm/7¼"	30mm
OR4050-16	19.5cm/7¾"	50mm
OR4070-16	20cm/8"	70mm



# RETRACTORS

## Charnley Vertical Retractor

- 24.5cm/9½" length
- 3x4 Sharp prongs
- Blade depth 22mm

OR4007-24



## Cones Self Retaining Retractor

- 3x4 Prongs
- Jointed arms



Blunt Prongs	Length	Depth	Sharp Prongs	Length	Depth
OR4064-13	13cm/5"	15mm	SP4063-13	13cm/5"	15mm
OR4066-16	16cm/6 ½"	15mm	SP4065-16	16cm/6 ½"	15mm
OR4068-20	20cm/8"	20mm	SP4067-20	20cm/8"	20mm
OR4070-24	24cm/9 ½"	25mm	SP4069-24	24cm/9 ½"	25mm

## Harvey Jackson Self Retaining Retractor

- 30.5cm/12" length
- Blade depth 45mm
- 3x3 Sharp prongs

OR4010-30





# RETRACTORS



## Charnley Horizontal Hip Retractor

- 28cm/11" length
- Blade depth 18mm
- Hinged joint
- 7" opening

OR4006-28



To retract the detached trochanter headwards, and the femur towards the feet

## Hardinge Horizontal Retractor

- Blade depth 18mm
- Hinged joint

OR4007-28



## Charnley Pin Retractor

Complete set with:

- T-handle introducer
- Pair of pins with chains

OR1100-00



OR1101-00 T-handle only



OR1102-00 Pair of pins with chain only

One pin, or sometimes two, is driven into the bone of the superior lip of the acetabulum, to stake back the capsule to give a clear view of the superior lip of the acetabulum. The nerve supply to the tensor fasciae femoris is preserved in this exposure by restricting dissection in the cleft in front of the gluteus medius, but this restricts exposure. By using pins to stake back the abductor muscles, a good exposure of the acetabulum can be obtained, and at the same time the nerve supply to tensor fasciae femoris can be preserved.

The short pins do not obstruct the surgeon's hand in access to the acetabulum. The chain is a safety device to prevent the pins being left in situ.

# RETRACTORS



## Viper Hinged Scoliosis Retractor

- 30cm/11¾" length
- Sharp

Depth Prongs

OR7248-38H	40mm
OR7248-40H	70mm
OR7248-50H	100mm

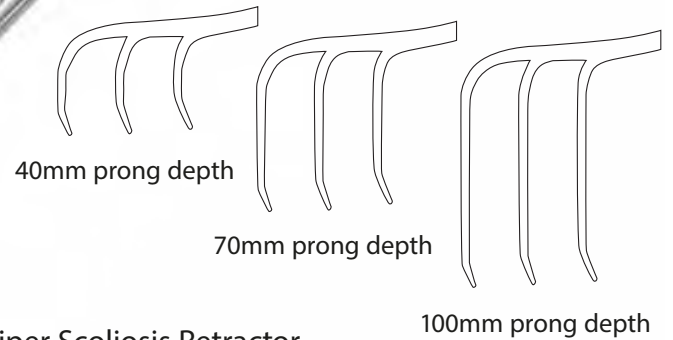
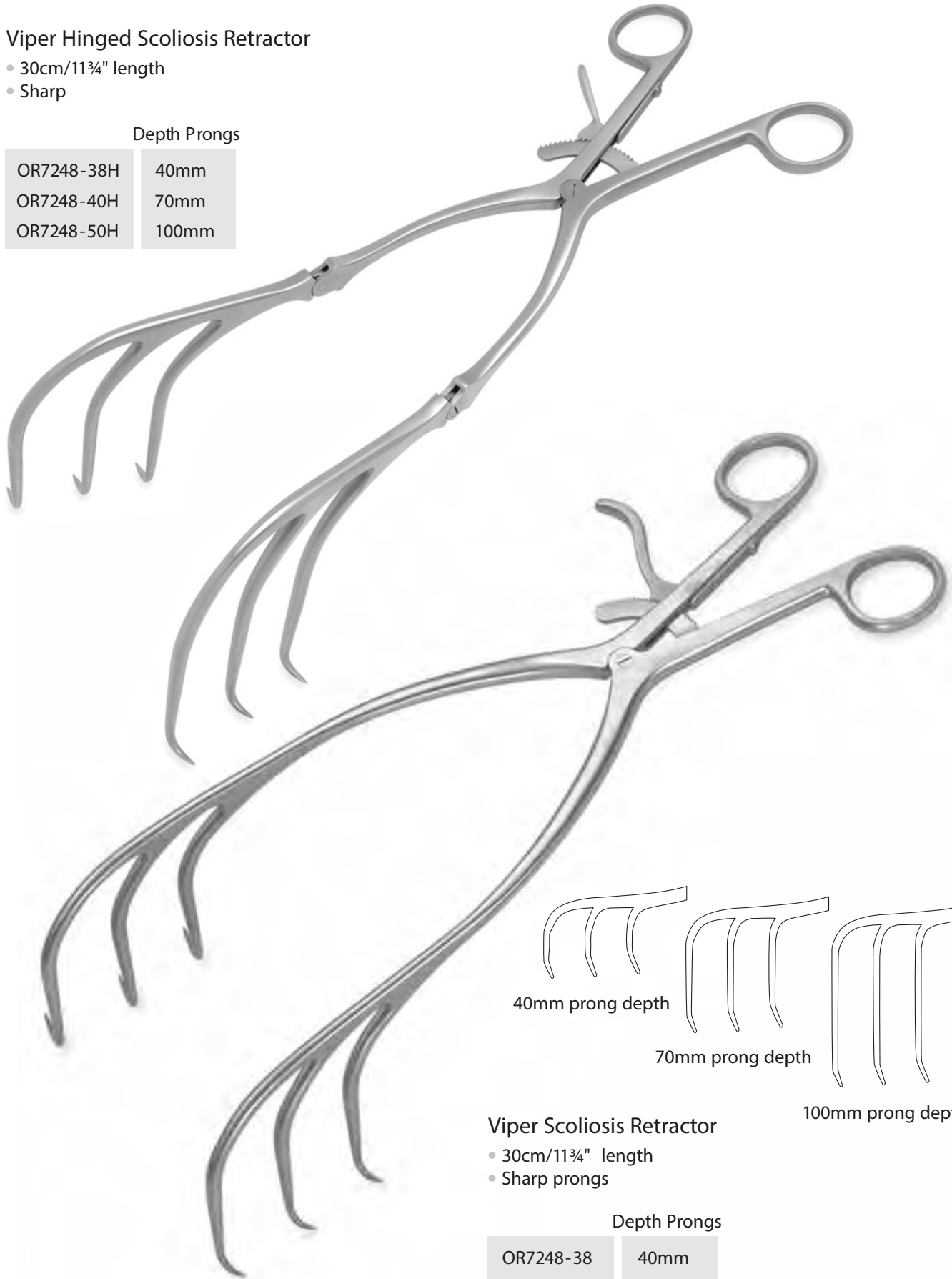

## Viper Scoliosis Retractor

- 30cm/11¾" length
- Sharp prongs

Depth Prongs

OR7248-38	40mm
OR7248-40	70mm
OR7248-50	100mm

# MALLETS



**MAST PAK SURGICAL CORP.**

## Toffee Mallet

19cm/7½" length  
Head size 22mm Ø  
Weight 165g/6oz

OR5808-21



## Ultra Fine Mallet

17cm/6¾" length  
Head size 20mm Ø  
Weight 145g/5oz

OR5801-17



## Heath Mallet

- 19cm/7" length
- Stainless steel head
- Head size 40mm Ø
- Weight 1020g/36oz

OR5809-19



## Mallet with Tufnol Handle

23cm/9" length

Small head size 30mm Ø  
Weight 350g/12oz

OR5803-23

Medium head size 35mm Ø  
Weight 550g/20oz

OR5804-23

Large head size 40mm Ø  
Weight 700g/25oz

OR5805-23



# MALLETS

## London Splint Mallet

- 18cm/7" length
- Head size 30mm Ø
- Weight 450g/16.2oz

OR5802-18



## Ombredanne Mallet

- 24cm/9½" length
- Head size 40mm Ø
- Weight 550g/20oz

OR5806-24



## Mallet with Tufnol Handle

- 24cm/9½" length
- Lead filled head
- Weight 400g/14oz

OR5810-24



## Tufnol Mallet

- 25.5cm/10" length
- Head size 42mm Ø
- Weight 250g/10oz

OR5807-25



# OSTEOTOMES

## Mini-Lambotte Osteotome 12.5cm/5" length



	Width
OR5270-02	2mm
OR5270-03	3mm
OR5270-04	4mm
OR5270-06	6mm
OR5270-08	8mm

Set of 5 sizes:  
2mm to 8mm

OR5270-28

## Lambotte Osteotome 25cm/9¾" length



Straight	Width
OR7970-04	4mm
OR7970-06	6mm
OR7970-08	8mm
OR7970-10	10mm
OR7970-13	13mm
OR7970-16	16mm
OR7970-18	18mm
OR7970-20	20mm
OR7970-25	25mm
OR7970-30	30mm

Curved	Width
OR7971-04	4mm
OR7971-06	6mm
OR7971-08	8mm
OR7971-10	10mm
OR7971-13	13mm
OR7971-16	16mm
OR7971-18	18mm
OR7971-20	20mm
OR7971-25	25mm
OR7971-30	30mm

## Ultra Fine Osteotome (Titanium Nitrate Coated) 16cm/6¼" length



	Width
OR5230-02	2mm
OR5230-04	4mm
OR5230-06	6mm
OR5230-08	8mm
OR5230-10	10mm
OR5230-12	12mm



Set of 6 sizes: 2mm to 12mm  
complete with mallet in  
sterilising case

OR5230-48

# OSTEOTOMES

## Mini- Stille Osteotome

16cm/6¼" length

Straight      Width

OR7704-16	4mm
OR7706-16	6mm
OR7708-16	8mm



## Stille (Swedish) Osteotome

• 20cm/8" length

Straight      Width

OR7706-20	6mm
OR7708-20	8mm
OR7710-20	10mm
OR7712-20	12mm
OR7715-20	15mm
OR7720-20	20mm
OR7725-20	25mm
OR7730-20	30mm



## Hibbs Osteotome with thin blade

• 20cm/8" length

• Extra thin blade

Straight      Width

OR7804-20	4mm
OR7806-20	6mm
OR7808-20	8mm
OR7810-20	10mm
OR7812-20	12mm
OR7815-20	15mm
OR7820-20	20mm
OR7825-20	25mm
OR7830-20	30mm

Curved      Width

OR7904-20	4mm
OR7906-20	6mm
OR7908-20	8mm
OR7910-20	10mm
OR7912-20	12mm
OR7915-20	15mm
OR7920-20	20mm
OR7925-20	25mm
OR7930-20	30mm



## Smith Petersen Osteotome

• 20cm/8" length

Width

OR7610-20	10mm
OR7615-20	15mm
OR7620-20	20mm
OR7625-20	25mm
OR7630-20	30mm



# OSTEOTOMES



## Mini-Lexer Osteotome

- 18cm/7" length
- Tufnol handle

OR5250-48 Set of 5 sizes:  
2mm to 10mm



	Width
OR5250-02	2mm
OR5250-04	4mm
OR5250-06	6mm
OR5250-08	8mm
OR5250-10	10mm

## Lexer Osteotome

- 22cm/8½" length
- Tufnol handle



	Width
OR7207-22	7mm
OR7210-22	10mm
OR7215-22	15mm
OR7220-22	20mm
OR7225-22	25mm

## Dahmen Osteotome

- 30cm/12" length
- Tufnol handle

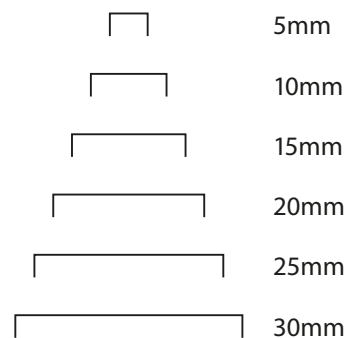

Straight	Width
OR7105-30	5mm
OR7110-30	10mm
OR7115-30	15mm
OR7120-30	20mm
OR7125-30	25mm
OR7130-30	30mm

Angled	Width
OR7305-30	5mm
OR7310-30	10mm
OR7315-30	15mm
OR7320-30	20mm
OR7325-30	25mm
OR7330-30	30mm



## Box Chisel

- 29cm/13½" length
- For preparation of the proximal femur
- 31mm width x 6mm

OR7031-29



## Pelvic Osteotome

- 30cm/12" length
- Tufnol handle
- Angled shaft

15mm width

OR7015-30

20mm width

SP7020-30



## Chisel with Interchangeable Blades

- 20cm/8" length
- Tufnol handle
- Very thin blades

OR0790-20

Complete set with 4 blades\* & key



### Blade Width

OR0792-05	5mm*
OR0793-08	8mm
OR0793-10	10mm*
OR0793-12	12mm
OR0794-15	15mm*
OR0795-25	25mm*

## Capener Lamina Gouge

- 23cm/9" length
- Cranked shaft

### Width

OR6506-23	6mm
OR6508-23	8mm
OR6511-23	11mm
OR6516-23	16mm





# BONE CURETTES



## Volkman Curette

- 22cm/8¾" length
- Double ended

	Size
OR8401-22	Small
OR8402-22	Medium
OR8403-22	Large

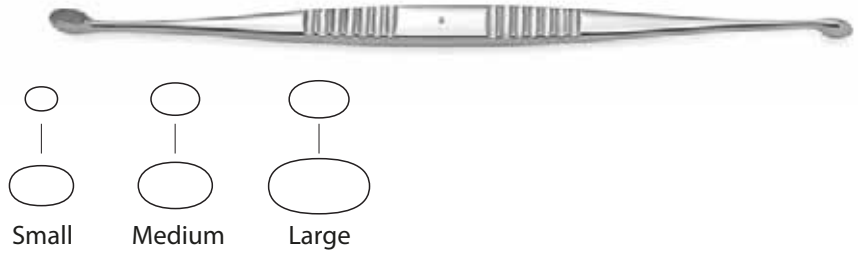

## Muller Curette with Tufnol Handle

- 27cm/9¾" length
- Tufnol handle



## Charnley Bone Curette

- 37cm/15" length
- T-handle



## Charnley Ring Curette

- 37cm/15" length
- Double sided
- Serrated cutting edge
- T-handle





# HIP REVISION INSTRUMENTS

## Cup Extraction Chisel

- 32cm/12½" length
- Curved 7mm tip
- Metal strike plate
- Tufnol handle



## Bayonet Gouge

- 32cm/12½" length
- Metal strike plate
- Tufnol handle
- 8mm width



## Swan Necked Gouge

- 28.5cm/11" length
- 25mm width



## Cement Gouge

- 34.5cm/13½" length



9mm width  
SP6509-34

11mm width  
SP6511-34

## Cement Chisel Angled 15°

- 35.5cm/14 length
- 9mm tip



OR6109-35





# HIP REVISION INSTRUMENTS

## Cement Osteotome

- 30cm/12" length
- Tufnol handle with strike plate



	Width
OR6105-30	5mm
OR6107-30	7mm
OR6110-30	10mm



## Cement Splitting Osteotome

- 30cm/12" length
- Tufnol handle with strike plate
- Guarded blade



	Width
OR6205-30	5mm
OR6210-30	10mm



## Straight Cement Gouge

- 30cm/12" length
- Tufnol handle with strike plate



	Width
OR6305-30	5mm
OR6307-30	7mm
OR6310-30	10mm



## Bayonet Cement Rasp

- 52cm/20½" length
- Tufnol handle

\*illustrated



OR6100-52



V-shape

OR6101-52



Strong round shape\*

OR6102-52



Flat round curve



# HIP REVISION INSTRUMENTS

## Bayonet Cement Chisel

- 40cm/15¾" length
- Tufnol handle with strike plate



## Bayonet Cement Splitting Osteotome

- 40cm/15¾" length
- Tufnol handle with strike plate
- Guarded blade



## Bayonet Cement Gouge

- 40cm/15¾" length
- Tufnol handle with strike plate



## Bayonet Cement Gouge

- 40cm/15¾" length
- Tufnol handle with strike plate

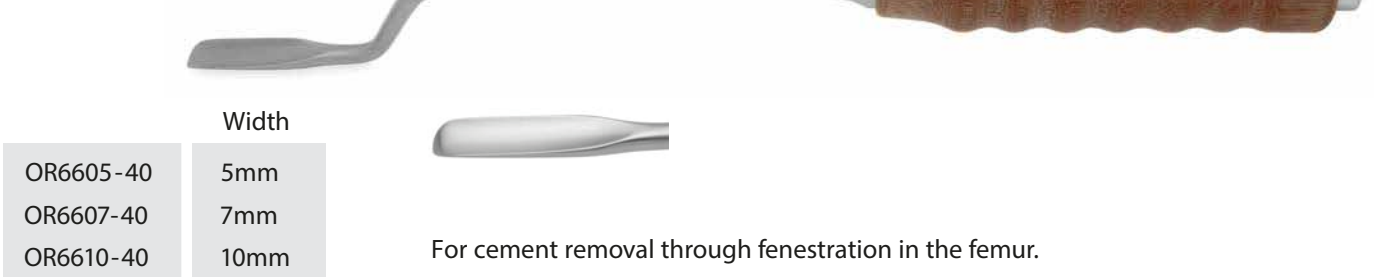



# HIP REVISION INSTRUMENTS

## Malleable Cement Probe

- 38cm/15" length
- For probing the Femur



OR6900-38



## Cement Plug Extractor

- 48cm/19" length
- T-handle
- For extraction of cement plug



Thread Dia.

OR6807-48	7mm
OR6809-48	9mm
OR6811-48	11mm



Used with a slotted mallet

## Retrograde Cement Chisel

- 50cm/19¾" length
- Tufnol T-handle
- Striking plate



Width

OR6805-50	5mm
OR6807-50	7mm
OR6810-50	10mm



## Slotted Mallet

OR6850-00



## Cement Extraction Hook

- 34.5cm/14" length

OR6905-34

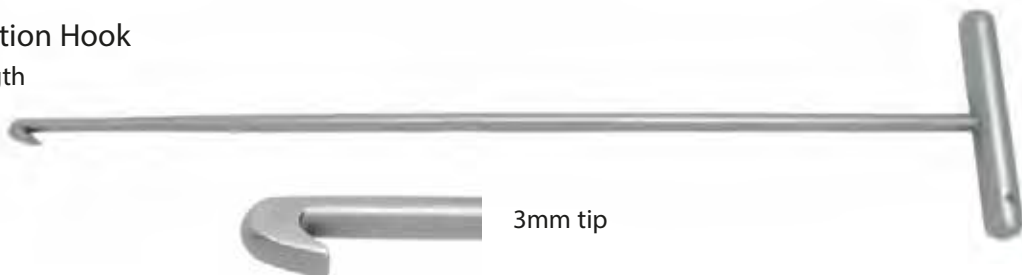

3mm tip

# HIP REVISION INSTRUMENTS



## Cement Twist Drill Long

- 40cm/15¾" length



### Diameter

OR1400-06	6mm
OR1400-08	8mm
OR1400-10	10mm

## Fine Cement Duckbill Grasping Forceps

- 35cm/14" shaft length
- Fine jaws



OR6901-35

## Heavy Cement Grasping Forceps

- 26cm/10" shaft length
- Serrated jaws 6mm width



OR6902-26

# HIP REVISION INSTRUMENTS



**MAST PAK SURGICAL CORP.**

## Femoral Head Extractor

- 23cm/9" length
- Tufnol handle

SP6916-23



## Moore Femoral Head Extractor

- 20.5cm/8" length
- Metal handle

SP6914-20



## Joint Capsule Clamp

- 21cm/8¼" length
- 25mm jaw length

SP6995-21



## Joint Capsule Scissors

- 25cm/9¾" length
- Angled blades

SP6910-25



# HIP JOINT INSTRUMENTS

## Femoral Head Impactor

- 20cm/8" length
- Nylon head

SP6918-20



## McGoey Bone Punch

- Double ended

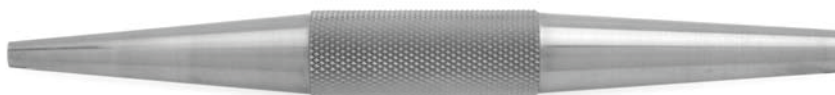

\* illustrated

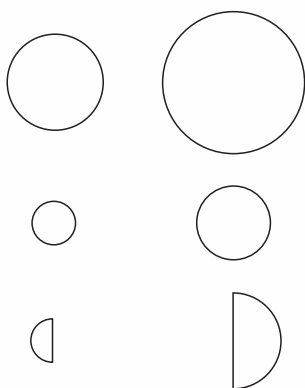

No 1. 13mm x 19mm Ø      OR6913-19      Large size

No 2. 6mm x 10mm Ø      OR6906-10      \*Small size

No 3. 6mm x 13mm Ø      OR6906-13  
With flats

## Hardinge Cement Restrictor

- 33.5cm/13<sup>3</sup>/<sub>4</sub>" length
- Graduated shaft



OR6920-33

## Femoral Pusher

- Square ended

OR6925-20







## Universal Fine Pliers and Cutters

- 15cm/6" length

OR7640-15

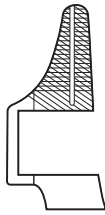

## Slim & Square Ended Wire Pliers

- 19cm/7½" length

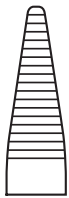

Slim Nose

OR7645-19

Serrated jaw



Square Ended\*

SP7644-19



\*illustrated

## Pliers for Screw Removal

- 20cm/8" length

OR5701-20



## Muller Claus Wire Pullers

- 18cm/7" length
- Double action
- Tungsten jaws

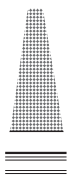

2mm Jaws

8-818E18

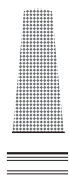

4mm Jaws

8-820E18



6mm Jaws

8-821E18



## Muller Claus Wire Cutters

- 16cm/6" length
- Tungsten carbide edges
- Cuts wire up to 1.6mm Ø

8-810E16



## Muller Claus Wire Cutters

- Tungsten carbide edges

8-810E18

- 18cm/7" length\*
- Cuts wire up to 2mm Ø

8-800E22

- 22cm/8¾" length
- Cuts wire up to 3mm Ø



\*illustrated

## End Wire Cutters

- 18cm/7" length
- Tungsten carbide edges
- Cuts wire up to 1.7mm Ø

8-816E18



## Bolt Cutters with dismantable arms

- Max. cap 6.3mm pins

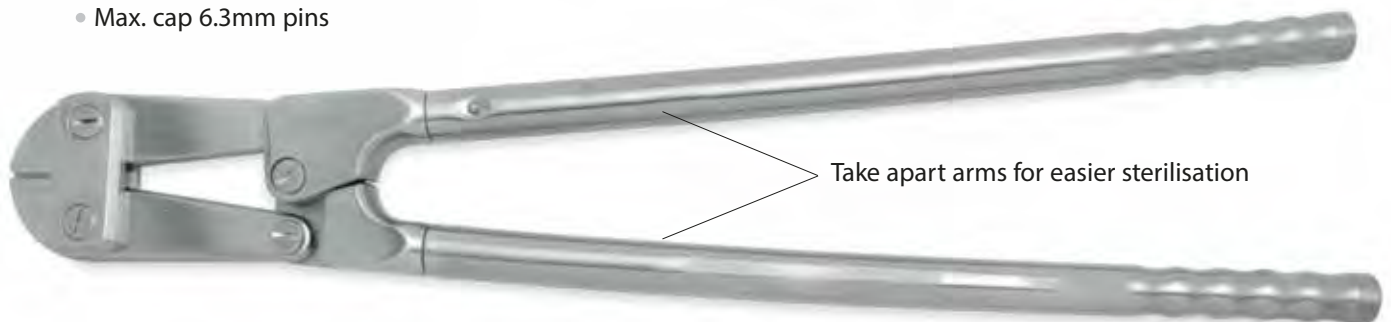

Take apart arms for easier sterilisation

200-500-585

- Must be used in conjunction with a Rod Holder. Ordering Code: 200-675-200

# WIRE CUTTERS



**MAST PAK SURGICAL CORP.**

## Combined Wire Cutters & Pliers

- 18cm/7" length
- Suitable for wires up to 1.6mm Ø
- Parallel closing jaws

200-512-185



## Wire Cutters with T/C Jaws

- 24cm/9½" length
- Double action
- Cuts plates & wires up to 2.7mm Ø

OR7644-24



## 'Power Cut' Wire Cutters

- 20cm/8" length
- Cutting inserts are T/C and can be replaced
- Cuts wires up to 3mm Ø

OR7645-20



# LOCKING PLIERS



## Needle Nosed Locking Pliers



Code	Length	
200-514-220	22cm/8¾"	Small
200-515-250	25cm/9¾"	Medium
200-516-300	30cm/11¾"	Large

- A very useful instrument for orthopaedic surgery allowing the surgeon to securely clamp on to wires and implants.



### Slap Hammer attachment combined

Code	Length	Weight
210-400-350	35cm/13¾"	400g
210-700-350	35cm/13¾"	700g

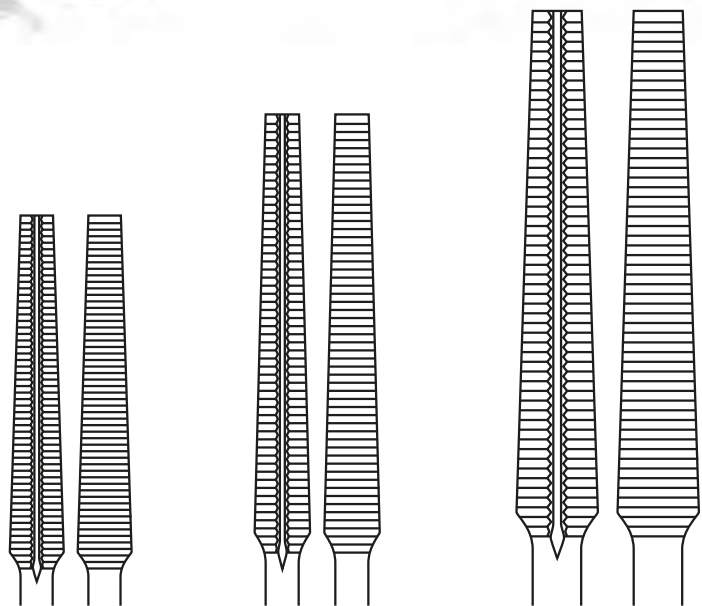

22cm/8¾" Small

25cm/9¾" Medium

30cm/11¾" Large

## Orthopaedic Locking Pliers

- Hardened jaws



Code	Length	
200-511-180	18cm/7"	Small
200-511-200	20cm/8"	Medium
200-511-240	24cm/9½"	Large

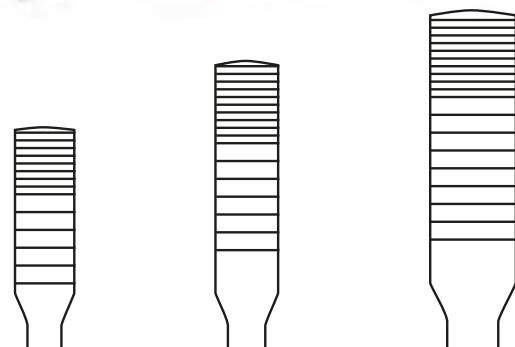

18cm/7" Small

20cm/8" Medium

24cm/9½" Large

# PIN INTRODUCERS



**MAST PAK SURGICAL CORP.**

## Kirschner Wire Introducing T-Handle

- 12cm/4¾" length
- 1.5mm Ø wires

OR5015-12



## Steinmann Pin Introducer T-Handle

- 14cm/5½" length
- 0.5mm - 8mm Ø pins
- With Jacobs chuck & key

OR5502-14



## Steinmann Pin Introducer T-Handle

- 14cm/5½" length
- 0.7mm - 6mm Ø pins
- Universal chuck

OR5507-14





### Bone Mill

- Table mounted with crank handle
- With removable cutting drum

OR6001-00

For grinding bone chips used for bone graft procedures.

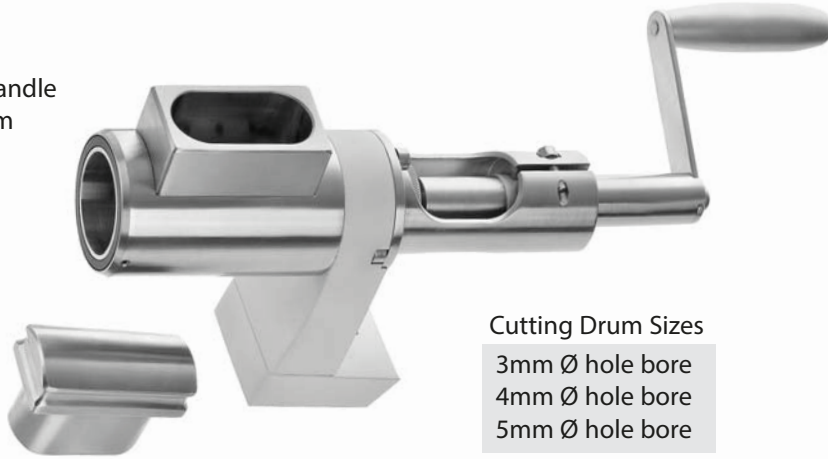

#### Cutting Drum Sizes

- 3mm Ø hole bore
- 4mm Ø hole bore
- 5mm Ø hole bore

### Wire Passing Guide

- 21cm/8¼" length



Used for passing wire around bones.

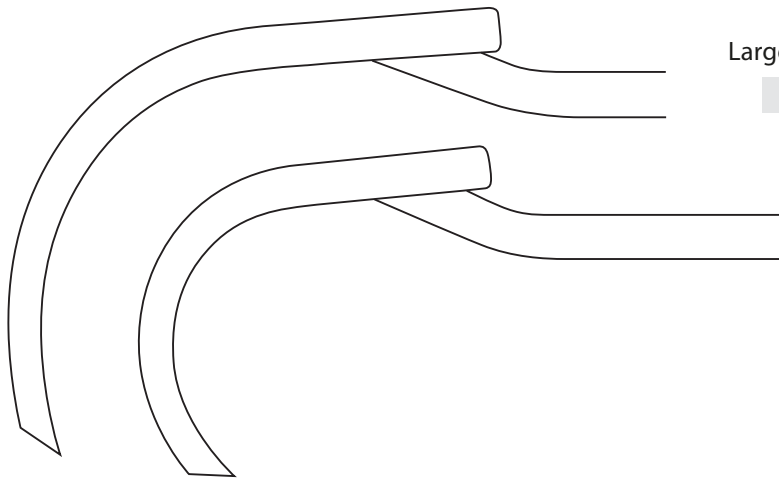

Large curve 70mm Ø

OR6105-21

Small curve 45mm Ø

OR6104-21

### Bone Awl

- Straight with eye

	Diameter	Length
OR5602-12	2.0mm	125mm
OR5602-13	2.4mm	130mm
OR5602-14	2.8mm	145mm
OR5602-15	3.2mm	160mm
OR5602-16	3.6mm	165mm
OR5602-17	4.0mm	175mm

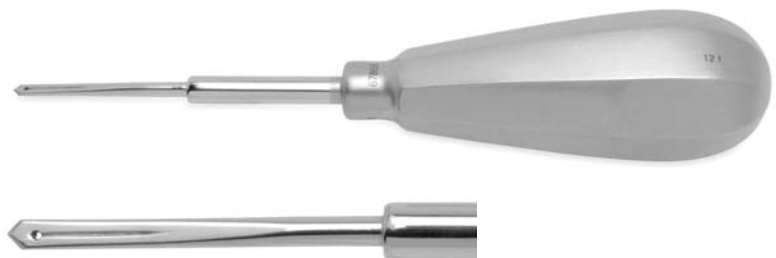

# SCREWDRIVERS



**MAST PAK SURGICAL CORP.**

## Slotted Head

- 17cm/6¾" length
- For head screws 2.7mm - 4.0mm

OR7014-17

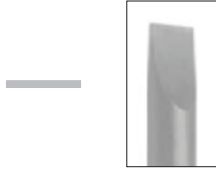

## Long Slotted Head

- 25cm/10" length
- For head screws 2.7mm - 4.0mm

OR7014-25

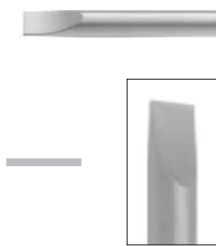

## Phillips Head

- 25cm/10" length
- For small Phillips head screws 6mm

OR7015-25

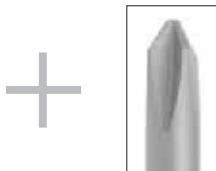

## Cross Slotted Head

- 25cm/10" length
- For cross slot screws 6mm

OR7016-25

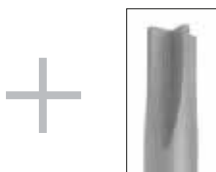

## Hexagonal Head

- 25cm/10" length
- For hexagonal head screws 2.7mm - 4.0mm

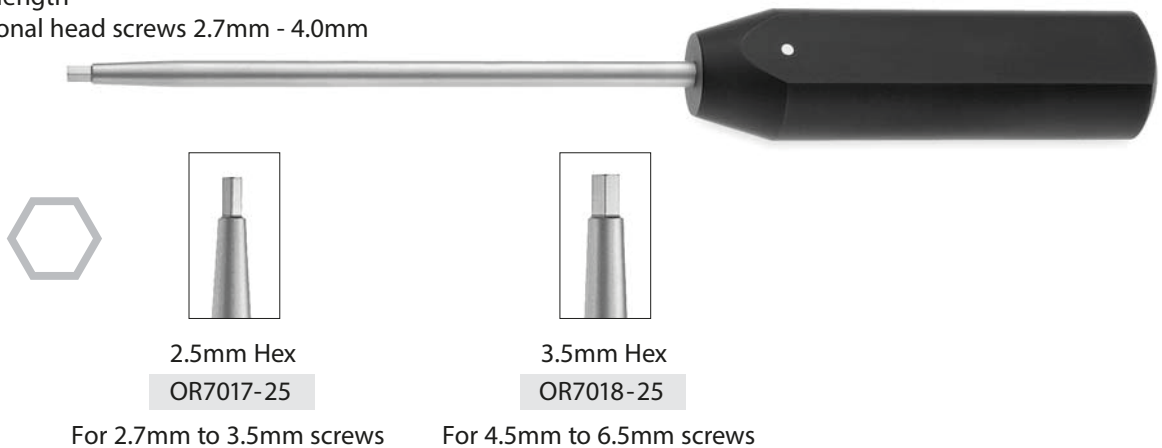

## Screwdriver Handle

- To fit shafts with quick lock attachment

OR7020-02



## Screwdriver Handle Small

- To fit shafts with quick lock attachment

OR7020-01



## Shaft with Quick Lock Fitting

- Hexagonal tip



Shaft	Diameter
OR7021-00	2.5mm
OR7022-00	3.5mm



# DISSECTORS

## Howarth Elevator

- 21.5cm/8½" length



OR9207-21

## MacDonald Elevator/Dissector



### Size

HA7105-19	19cm/7 ½"
OR9206-23	23cm/9"

## Watson Cheyne Dissector



### Length

HA7203-18	18cm/7"
OR9203-23	23cm/9"
OR9203-25	25.5cm/10"

## Freers Elevator/Dissector

- 18.5cm/7¼" length



OR7602-18

## Swedish Dissector

- 18cm/7" length



OR9201-18

# MEASURING INSTRUMENTS



## Stainless Steel Measuring Ruler

Code	Length
OR5005-15	15cm/6"
OR5005-30	30cm/12"



## Measuring Caliper

- 25cm/10" length
- Measuring range 0-50mm

OR7334-20



## Vernier Caliper

- 22.5cm/9" length
- Measuring range 15cm

OR7338-00



## Depth Gauge

- Measuring depth up to 50mm

OR7350-00



## Depth Gauge

- Measuring depth up to 70mm

OR7370-00



## Direct Reading Depth Gauge

- 23cm length
- Measuring depth up to 40mm

OR7333-10





# Mast Pak

*Surgical Corporation*

Manufacturer & Exporters of surgical instruments

## **Mast Pak** **SHOULDER SURGERY** **INSTRUMENTS**



Website: [www.mastpaksurgicalcorp.com](http://www.mastpaksurgicalcorp.com)

Email: [info@mastpaksurgicalcorp.com](mailto:info@mastpaksurgicalcorp.com)

Phone: +92-324-8609456

Address: Pacca Garha, Kashmir Road  
Sialkot 51310, Pakistan

# BONE TUNNELLING & SUTURE PASSING



## Penetrating Bone Gouge

- 22cm/8 3/4" length
- 3mm wide tip

SM0804-22



## Percussion Bone Awl

- 22cm/8 3/4" length
- Curved, with metal handle

SM0805-22

## Penetrating Bone Awl

- 18cm/7" length
- Tufnol handle

SM0806-18



## Crochet Hook Suture Passer

- 18cm/7" length
- Tufnol handle

SM0807-18



## Suture Passer

- 18/7"cm length
- Tufnol handle
- With hole in tip

SM0808-18



The Bone Awls and Suture Passers are used to place sutures along the edge of the Glenoid Rim.

# BONE PEFORATING FORCEPS & ELEVATORS

## Glenoid Perforating Forceps Light Curve

- 17cm/6 3/4" length
- Light curve

SM1858-17

For perforating holes in the Glenoid Rim.

## Glenoid Perforating Forceps Strong Curve

- 17cm/6 3/4" length
- Strong curve

SM1859-17

## Kolbel Glenoid Elevator

- 30cm/12" length
- 15mm width
- Curved
- Double prong

SM0596-15



## Kolbel Glenoid Elevator

- 30cm/12" length
- 20mm width
- Curved
- Double prong

SM0598-20



## Posterior Glenoid Elevators

- Curved tip to sit on posterior rim of Glenoid
- For Posterior Retraction of the Humeral Head



Width tip

SM0575-08	8mm
SM0575-12	12mm
SM0575-20	20mm

# HUMERAL HEAD RETRACTORS



**MAST PAK SURGICAL CORP.**

## Skid Lever

- 28cm/11" length
- Double ended
- 20mm and 30mm blade widths

SM0589-23

---

## Humerus Head Retractor

- 18cm/7" length
- Strongly curved
- Double blunt prongs

SM0592-18



---

## Bhattman Humerus Head Retractor

- 25cm/9 <sup>3</sup>/<sub>4</sub> length
- 30mm width
- Double prong

SM0590-30



# ELEVATORS

## Fukuda Humerus Head Retractor

- 22.5cm/9" length
- Fenestrated

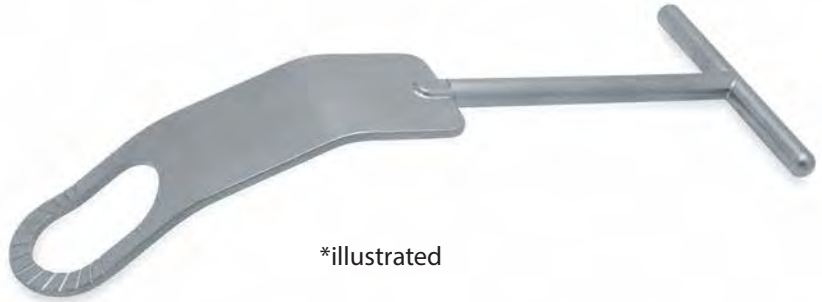

\*illustrated

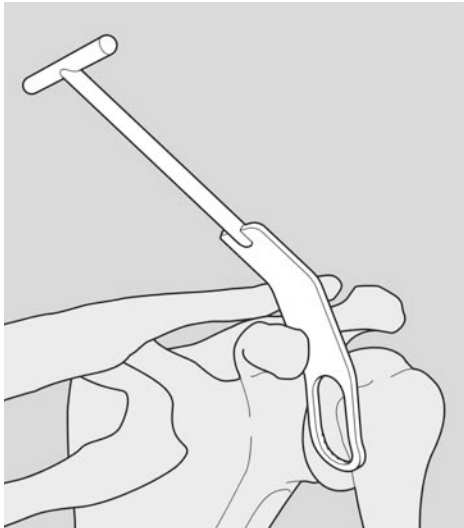

	width
SM0594-32	32mm
SM0594-22	35mm*
SM0594-37	37mm

## Darrach Acromial Elevators



\*illustrated

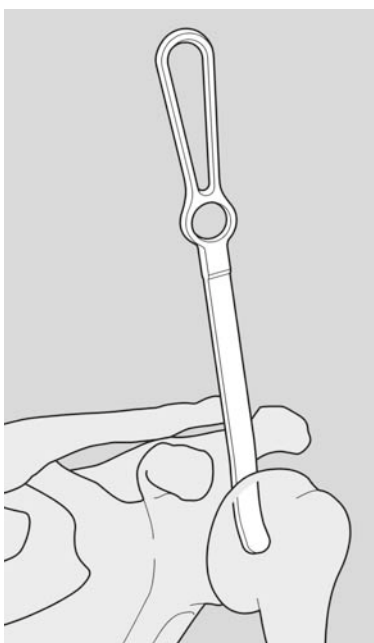

Small 9mm width, 26cm/10 1/4" length

SM0599-09



Medium 12mm width, 26cm/10 1/4" length

SM0599-12



Large 16mm width, 26cm/10 1/4" length\*

SM0599-16



Extra Large 25mm width, 36cm/14 1/4" length

SM0599-25

Set of 4 Elevators

SM0599-00

# SUB-ACROMION SPREADERS



**MAST PAK SURGICAL CORP.**

## Subacromion Spreader

- 19cm/7 1/2" length
- Small size

OR6551-19 left side ring\*

OR6552-19 right side ring



illustrated\*

---

## Subacromion Spreader

- 25cm/9 3/4" length
- Large size



6553-25 left side ring\*

SM6554-25 right side ring

illustrated\*

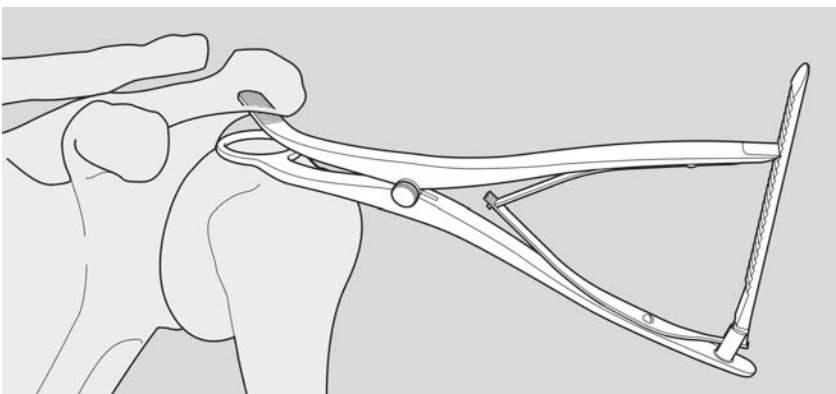

These spreaders are used when access is required to the subacromion area. The spreaders distract the humeral head from the acromion.



# SOFT TISSUE & MUSCLE RETRACTORS



**MAST PAK SURGICAL CORP.**

## Kolbel Tissue & Muscle Spreader

- 18cm/7" length
- Straight single blunt prongs

SM6442-18



## Kolbel Tissue & Muscle Spreader

- 18cm/7" length
- Angled single blunt prongs

SM6443-18

## Kolbel Tissue & Muscle Spreader

- 18cm/7" length
- Angled double blunt prongs

SM6441-18

## Capsule Spreader

- 18cm/7" length
- Single blunt prongs
- 90° Angled

SM6445-18

# SOFT TISSUE RETRACTOR

## Kolbel Shoulder Retractor

- With 3 pairs of detachable blades
- 23cm/9" length

SM1062-23

Complete set with 3 pairs of blades and retractor frame

SM1062-00

Retractor frame only

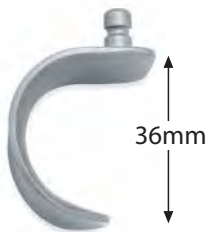

SM1063-36  
Small blade



SM1064-53  
Medium blade



SH1065-68  
Large blade

## Browne Deltoid Retractor

- 27cm/10 1/2 length
- 60mm x 65mm blade
- Cupped blade

SM0500-27

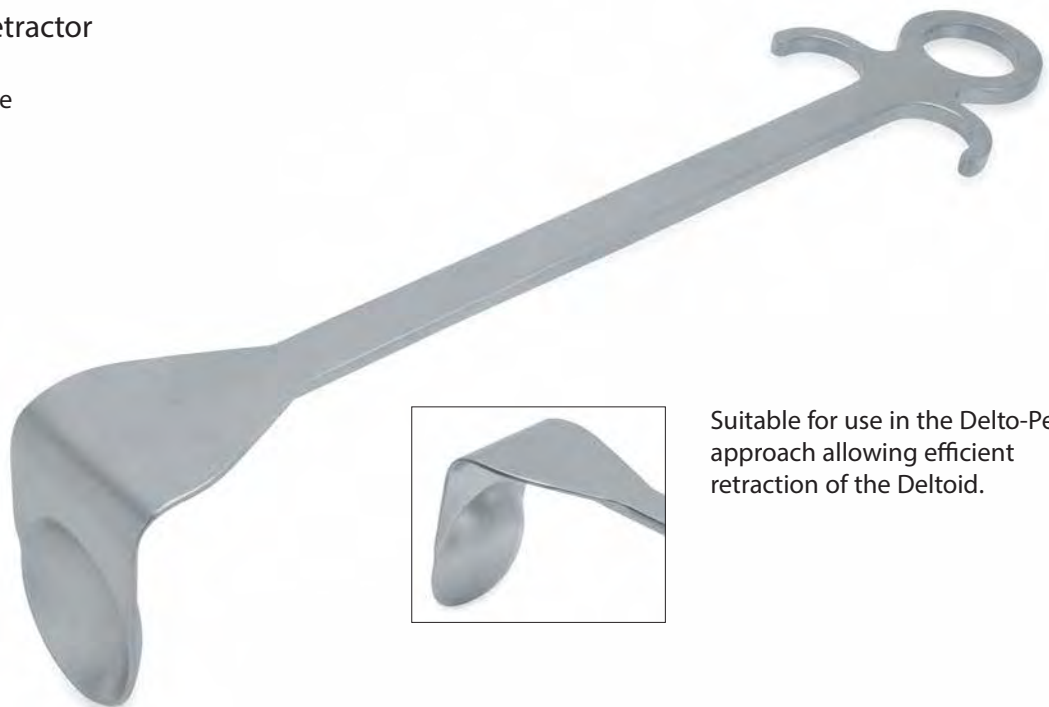

Suitable for use in the Delto-Pectoral approach allowing efficient retraction of the Deltoid.

# SHOULDER RETRACTOR



**MAST PAK SURGICAL CORP.**

## Titanium Bladed Shoulder Retractor

Complete set with:

- 1x Frame
- 2x Blade holders
- 2 Sets of Titanium blades
- Sterilizing container

SM1007-00



### Frame with Articulating Joints

- Quick lock + unlock for blades
- Maximum spread 10cm

SM1088-00

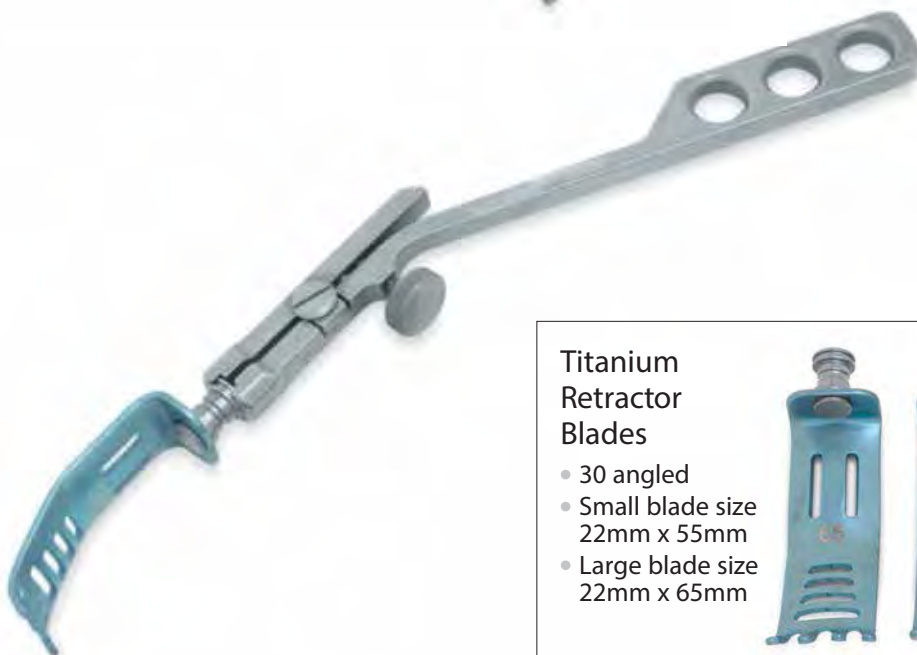

### Blade Holder

SM1009-00

### Titanium Retractor Blades

- 30 angled
- Small blade size 22mm x 55mm
- Large blade size 22mm x 65mm





## Richardson Retractor

- 20mm width
- 24cm/9 1/2 length

SM2054-20

---

## Richardson Retractor

- 28mm width
- 24cm/9 1/2 length

SM2053-28

---

## Kolbel Tenectomy Rongeur

- 18cm/7" length
- Jaws 3mm bite
- Strong curved

SM1258-19

---

## Kolbel Bone Nibblers

- 18cm/7" length
- Jaws 5mm bite
- Light curved

SM1256-19

---



## Mallet

- 24cm/9 1/2 length
- Tufnol handle
- 480 grams

SM0900-24

---



## Chisel with 4 Interchangeable Blades

- 20cm/8" length
- Tufnol handle
- Complete with blade sizes:  
5mm, 10mm, 15mm, 25mm & key

SM0790-20

---



# Mast Pak

*Surgical Corporation*

Manufacturer & Exporters of surgical instruments

Website: [www.mastpaksurgicalcorp.com](http://www.mastpaksurgicalcorp.com)

Email: [info@mastpaksurgicalcorp.com](mailto:info@mastpaksurgicalcorp.com)

Phone: +92-324-8609456

Address: Pacca Garha, Kashmir Road  
Sialkot 51310, Pakistan

